

Simple Model

Automatic Multifunctional Powder Packing Machine

30-50BAGS/MIN



Smarter And
Easy Operation



Ruian Mingyuan Machinery Co., Ltd

03

PART1

Parameters

05

PART2

Selling Points

12

PART3

After-sales

14

PART4

Certificates

15

PART5

Company Image

CATALOGUE

Catalogue Of Product Album



Click to jump to pages



MINGYUAN
MACHINERY

Ruian Mingyuan Machinery Co., Ltd

Parameters

03



Style Number	MY-FBQ100	MY-FBQ300
Bag Length	50-150mm	50-300mm
Bag Width	25-120mm	70-190mm
Film Width	50-260mm	140-400mm
Bag Capacity	5-100ml	100-1000ml
Packing Speed	30-50 bags/min	20-30bags/min
Power	220V/50hz 1.6KW	220V/50hz 1.8KW
Machine Size	760*980*1700mm	900*1110*2100mm
Machine Weight	300kg	500kg
Sealing Type	Three side seal, four side seal, back seal	
Air Source	0.6Mpa. 100L/min	
Form Of Measurement	Screw metering	
Packing Material	Multilayer composite film, polyester/PE, polyester/aluminum foil/PE, polyester/aluminized/PE, paper/PE	
Suitable For The Material	Food, medicine, chemical, daily chemical industry and other powdery materials	

OEM (Show Client Company Name in Machine Panel) is welcome in our factory



Click To View Machine Video

Ruian Mingyuan Machinery Co., Ltd

Parameters

04



Style Number	MY-FBD100	MY-FBD300
Bag Length	50-150mm	50-300mm
Bag Width	25-120mm	70-190mm
Film Width	50-260mm	140-400mm
Bag Capacity	5-100ml	100-1000ml
Packing Speed	30-50 bags/min	20-30bags/min
Power	220V/50hz 2.6KW	220V/50hz 2.6KW
Machine Size	760*980*1700mm	900*1110*2100mm
Machine Weight	380kg	580kg
Sealing Type	Three side seal, four side seal, back seal	Back sealing
Form Of Measurement	Screw metering	
Packing Material	Multilayer composite film, polyester/PE, polyester/aluminum foil/PE, polyester/aluminized/PE, paper/PE	
Suitable For The Material	Food, medicine, chemical, daily chemical industry and other powdery materials	

OEM (Show Client Company Name in Machine Panel) is welcome in our factory



Click To View Machine Video

Ruian Mingyuan Machinery Co., Ltd

Servo Driver

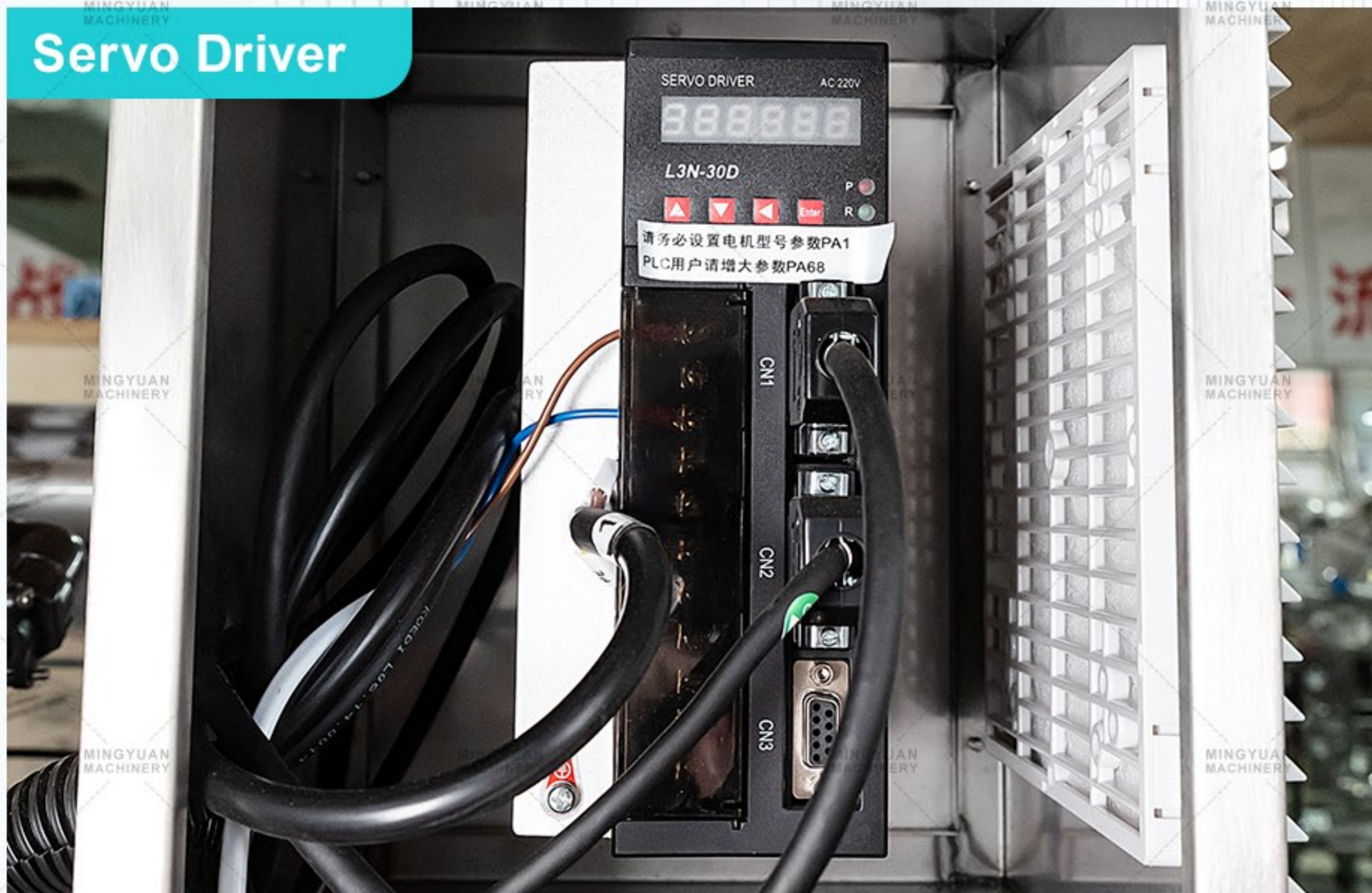

Servo motor control, with simple operation and accurate running.

Intelligent Photoelectric Control Device



Color photoelectric sensor position and pack accurately to ensure bag pattern integrity. With intelligent photoelectric control device , ensure the perfect shape of the packaging bag.

Selling Points

06

Feeding Unit Position Adjustable Wheel

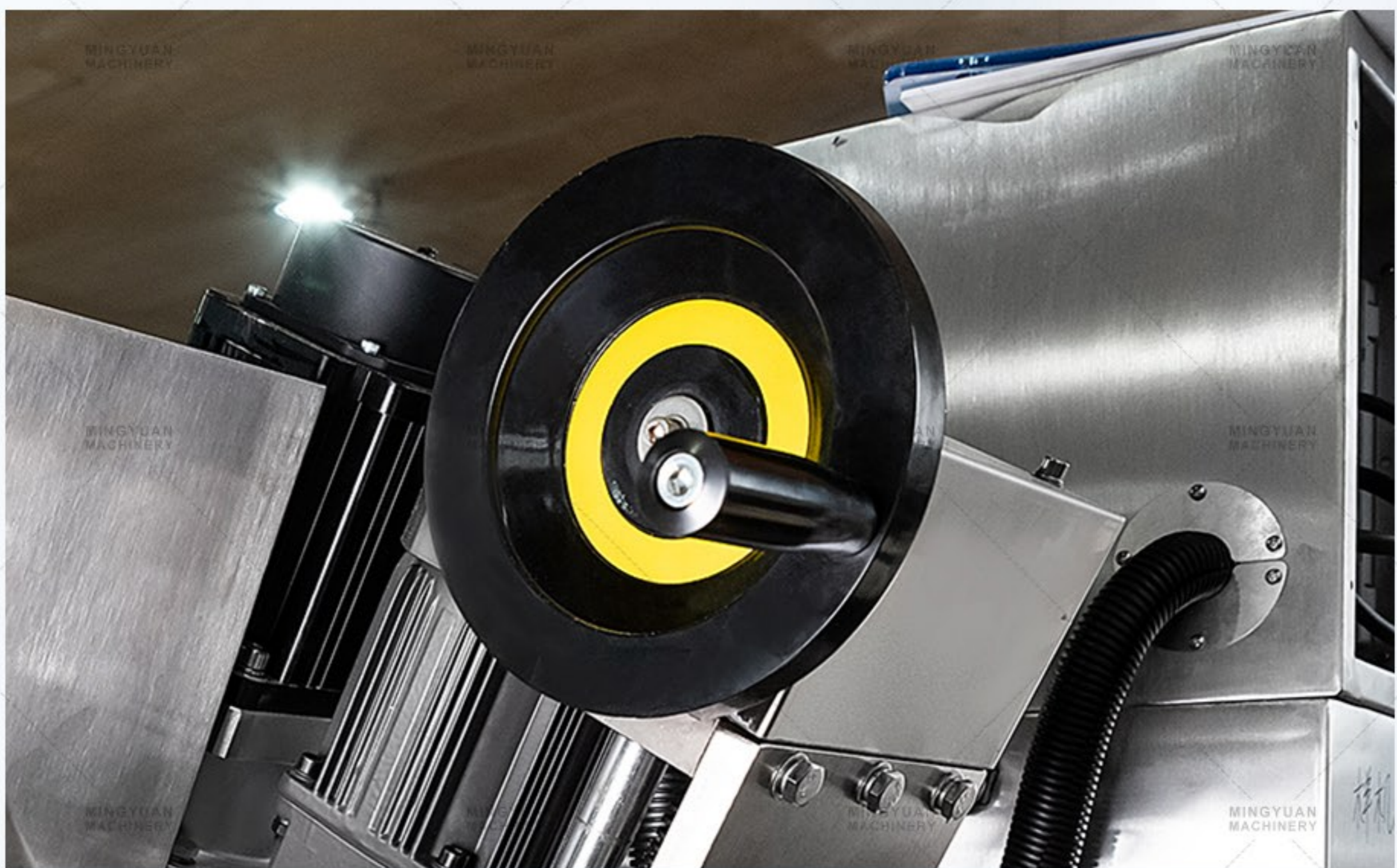

The height and the angel of the feeding unit can be ajustable, easy operation.

Ruian Mingyuan Machinery Co., Ltd

Selling Points

07

Roll Film Holder



Consists of multiple film-penetrating shafts, the film is pulled more smoothly and stably, and the bag is smoother and more beautiful.

Feeder Motor

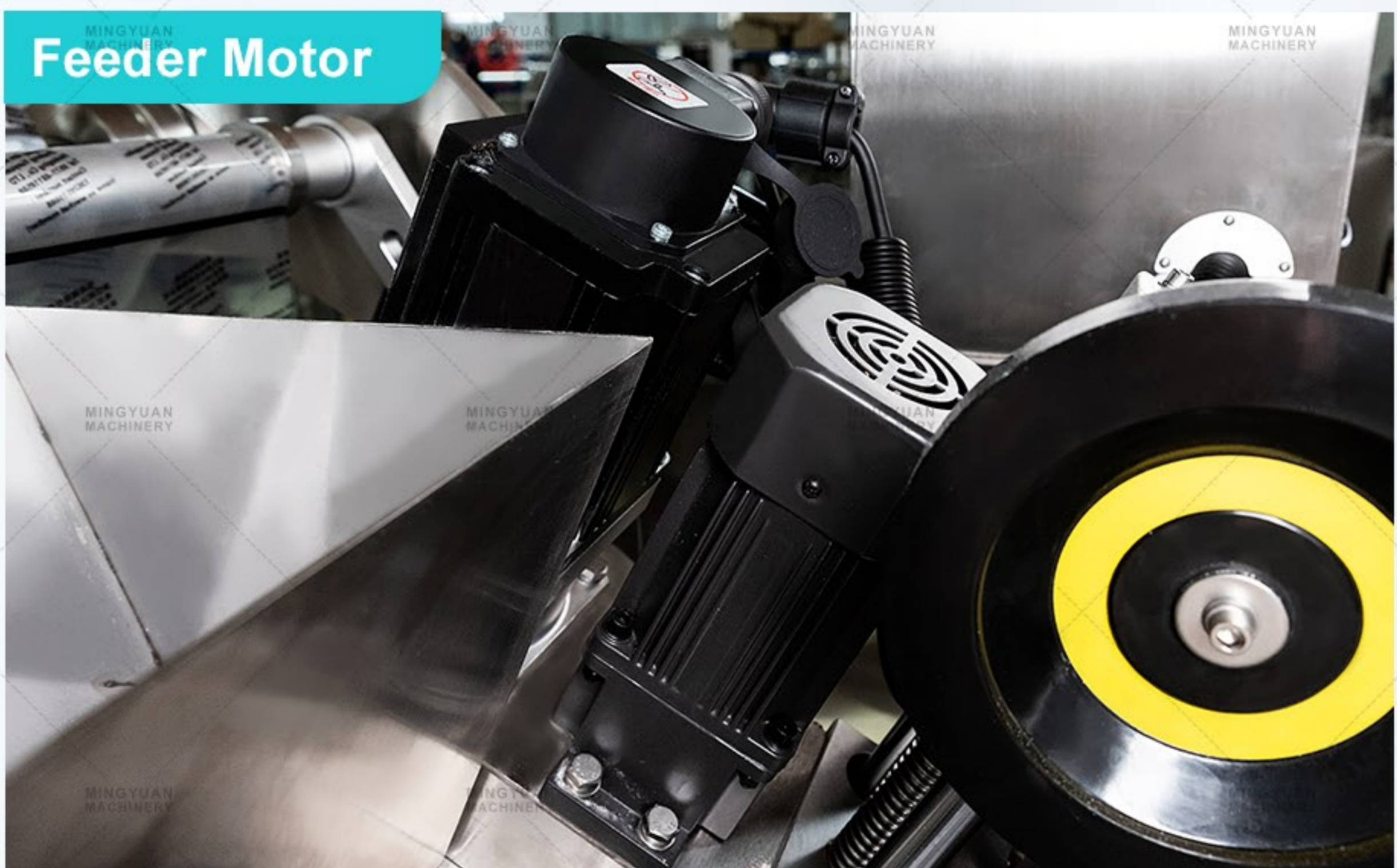

Stable power feeding.

Ruian Mingyuan Machinery Co., Ltd

Selling Points

08

Vertical Sealing System

儿机械有限公司

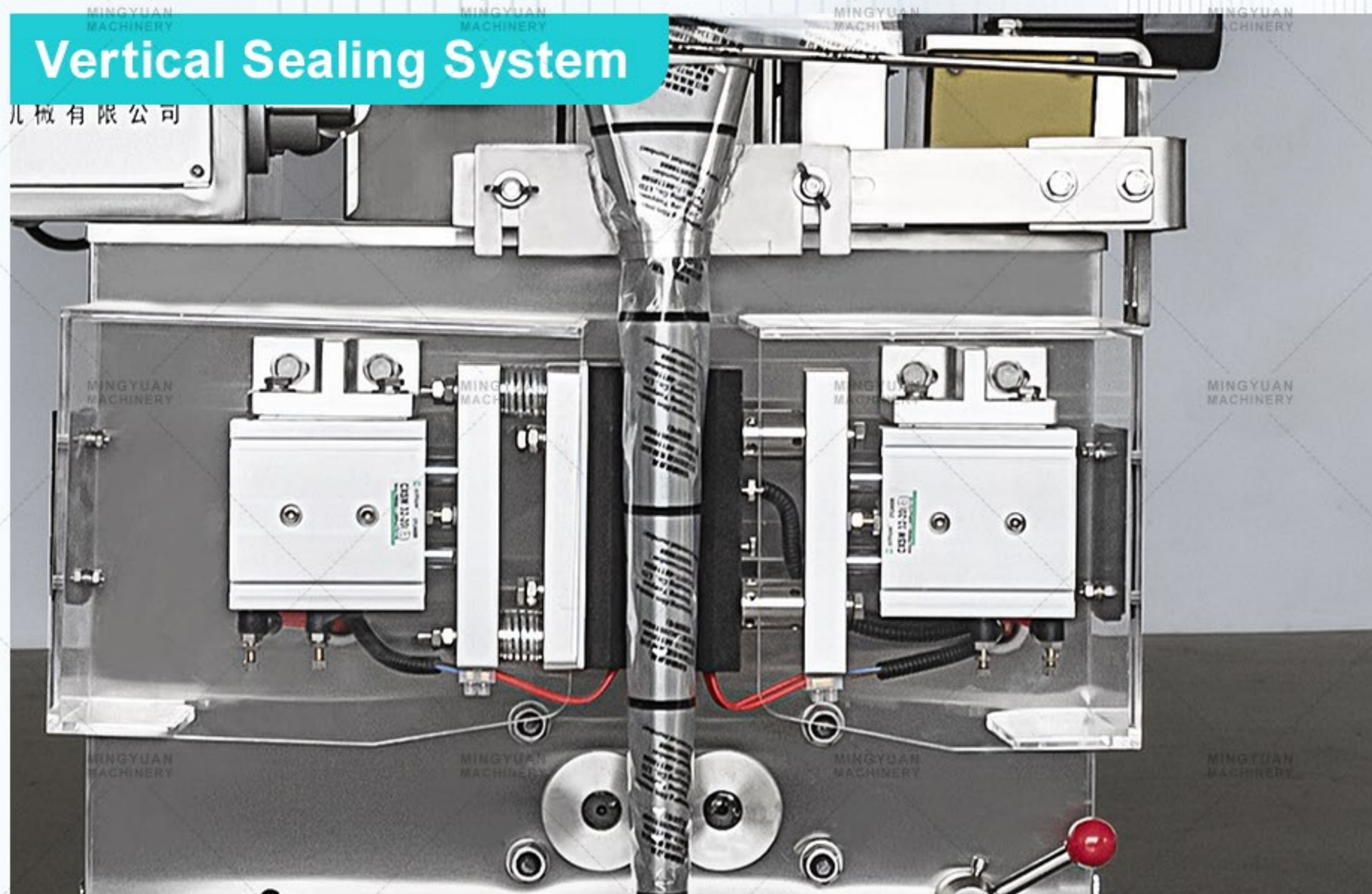

Intelligent PID constant temperature heating and sealing, make the beautiful bag shape.

Easy Control Touch Screen

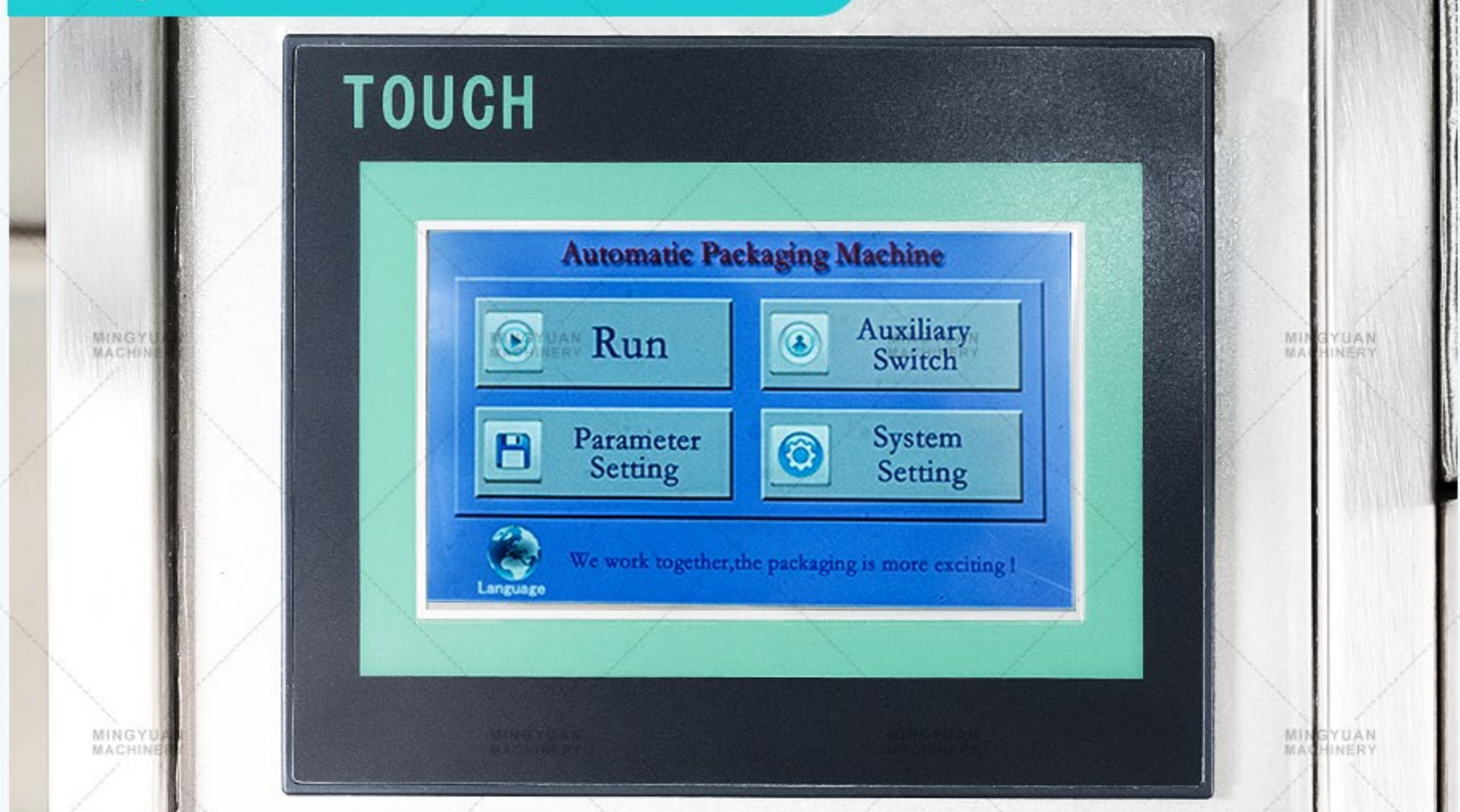

It adopts PLC Controller and colourful touch screen, all the working parameters can be setup on the control panel, which is easy to operate.

Ruian Mingyuan Machinery Co., Ltd

Selling Points

09

Screw Metering Feeder



Driven by the servo motor, control the number of screw revolutions, improve the accuracy of the same amount of feeding.

Large Capacity Hopper

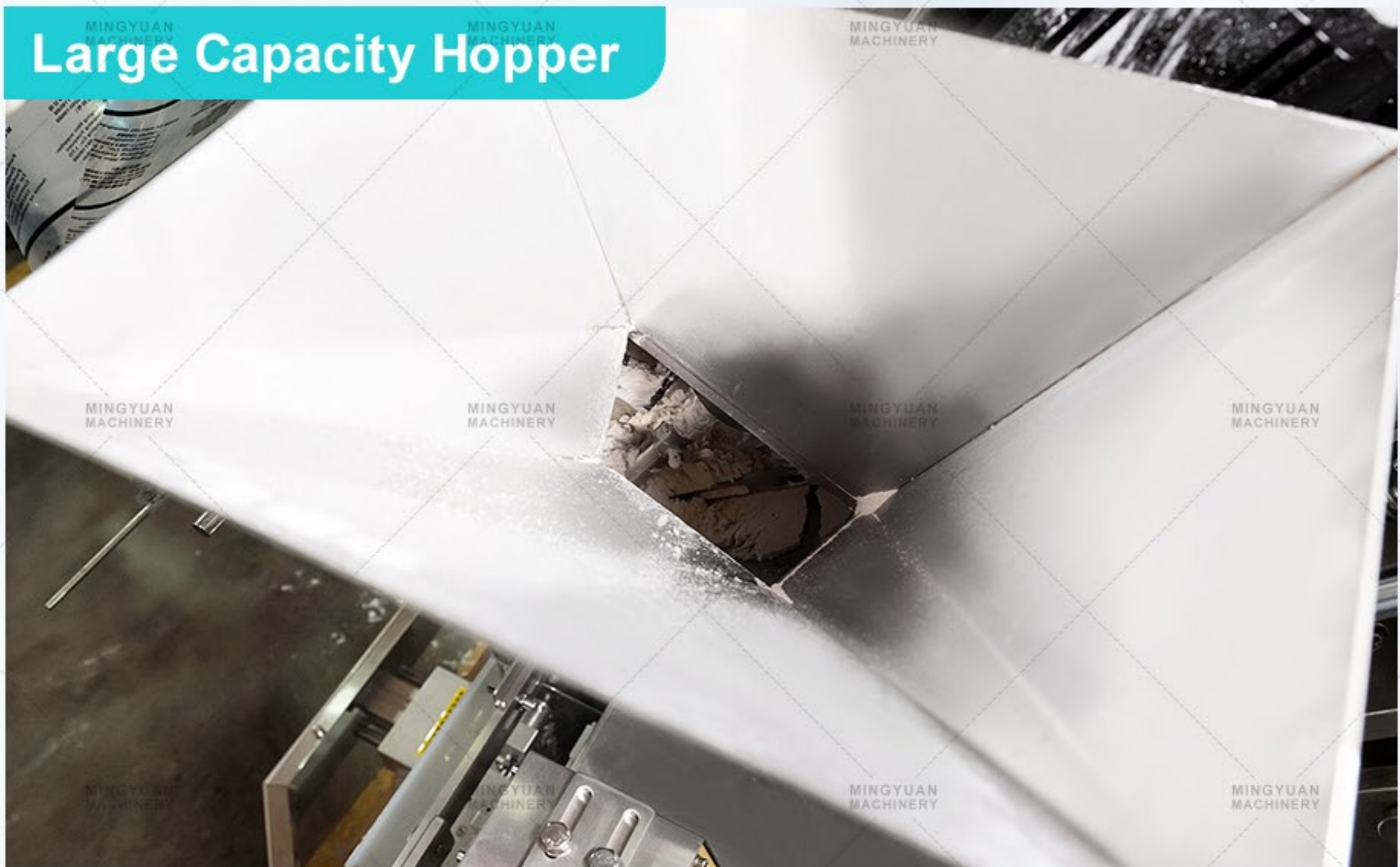

304 stainless steel is used for the whole contact material parts, which conforms to the food and drug hygiene licensing standards.

Ruian Mingyuan Machinery Co., Ltd

Selling Points

10

Pulling Wheels

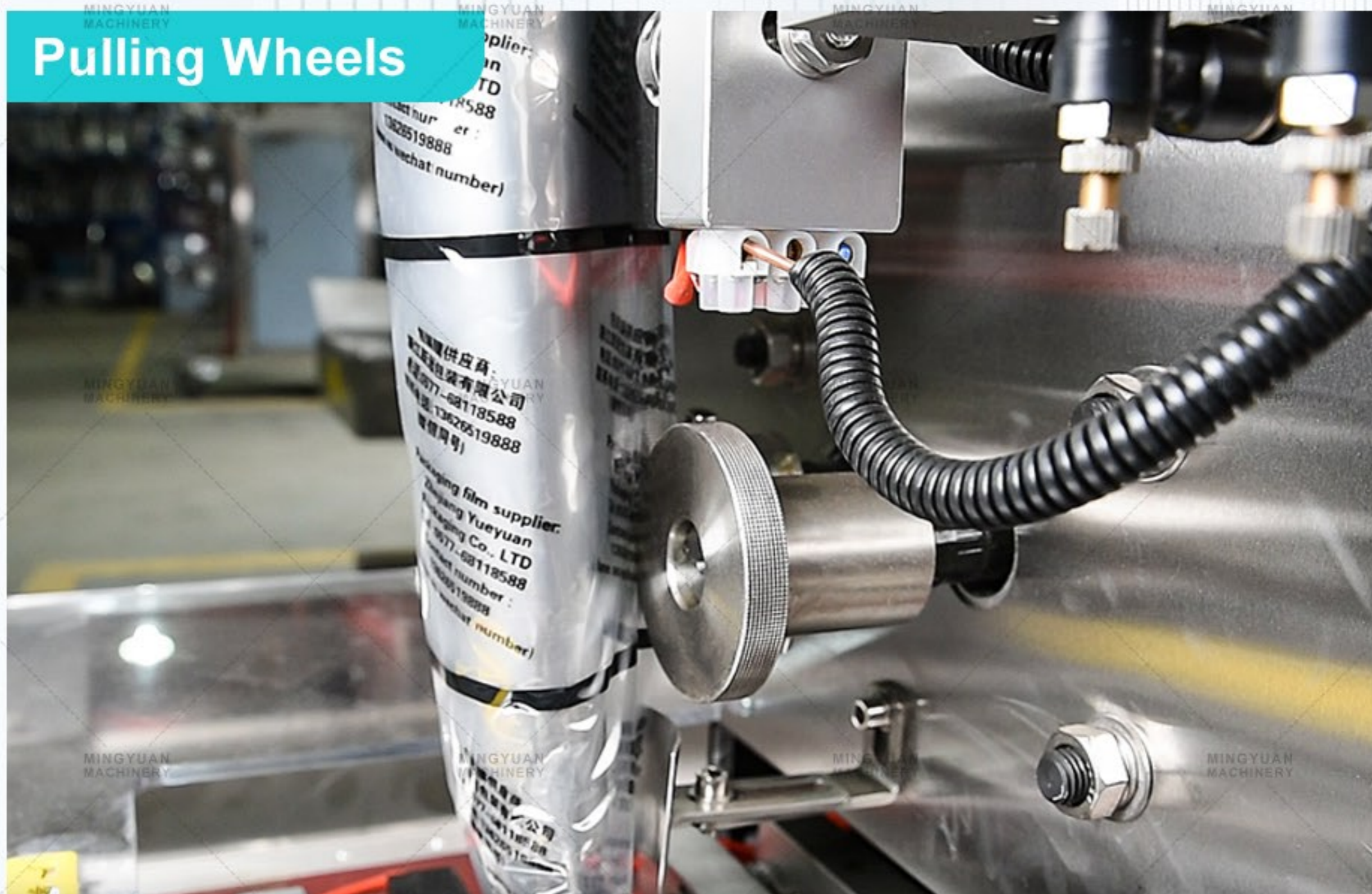

Pulling the film smoothly.

Horizontal Sealing And Cutting System

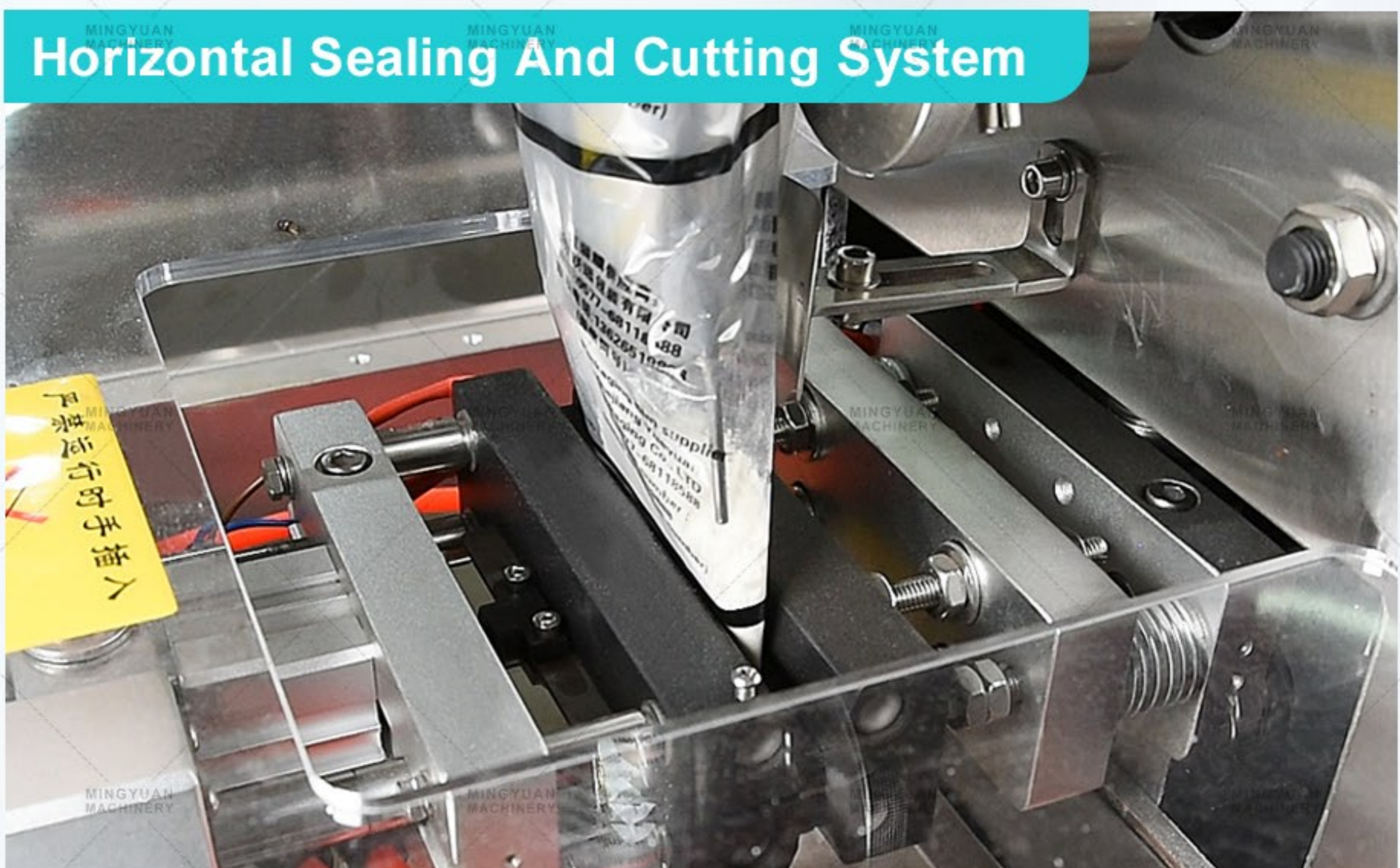

Sophisticated cutting structure with independent temperature system for bag sealing and cutting, achieve the consistency of bag sealing and cutting.

Ruian Mingyuan Machinery Co., Ltd

Why Choose Us

Our Machines



30-50bags/min

Normal Machines



25-35bags/min

Vs

The Speed is **More Faster And Stable** Than Normal



304

304 stainless steel

Vs

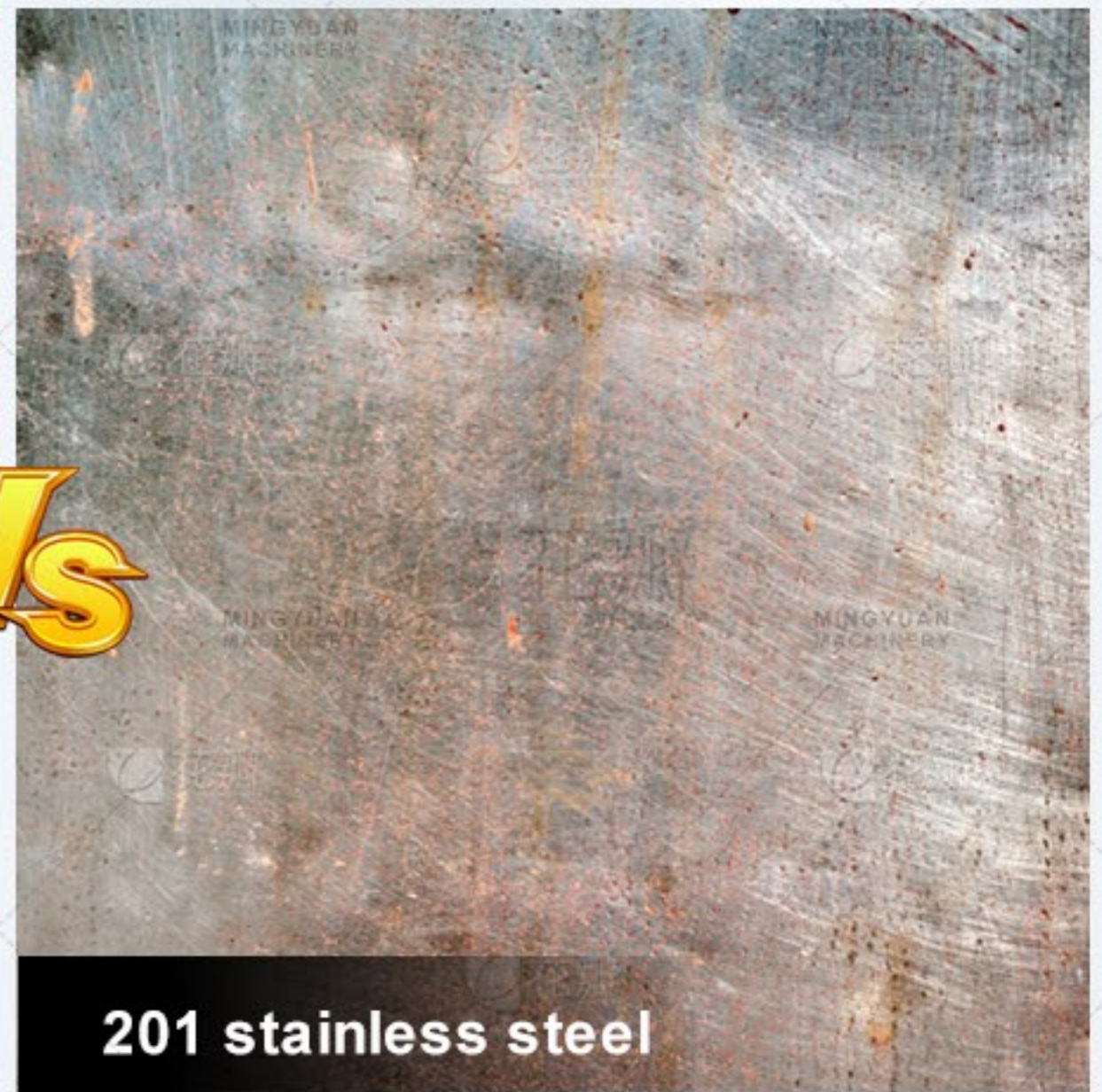

201 stainless steel

Adopt **SS304 Materil** Which Is More Safer Than **SS201**



Three In One

Vs

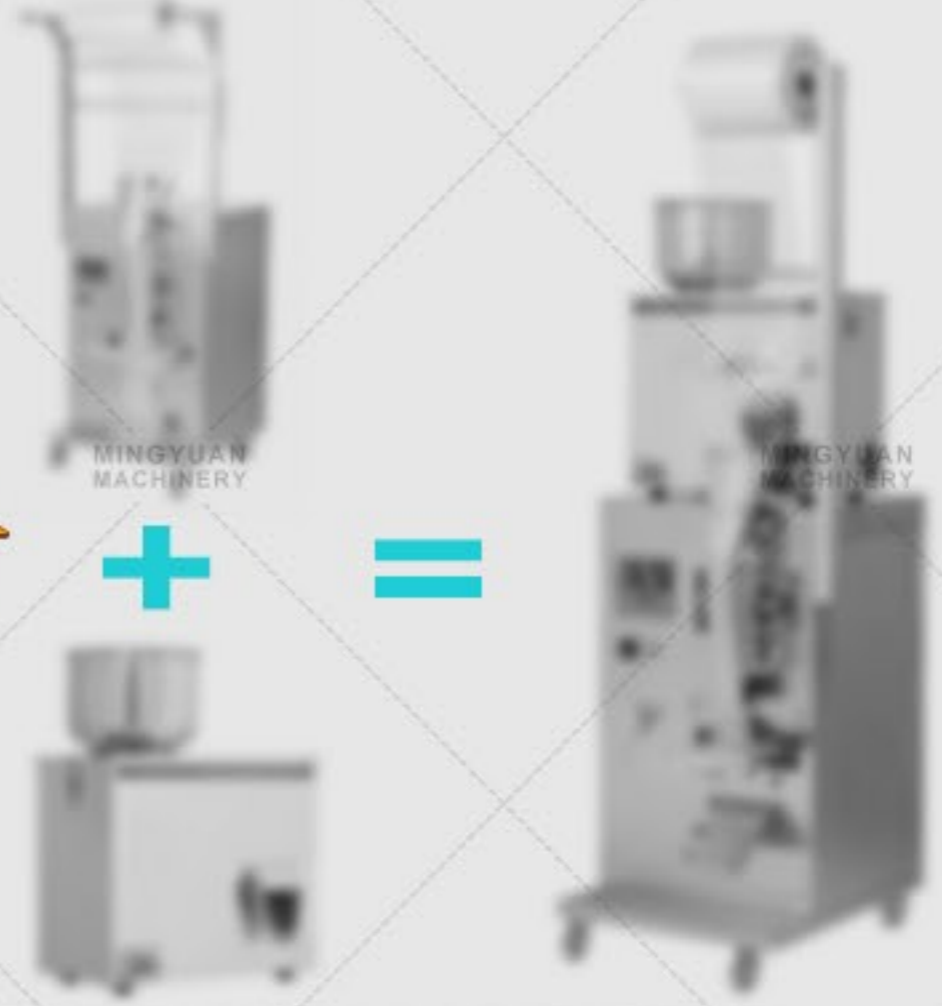

Need Weighing Machine

New Design With **Weighing, Filling And Sealing** Together In One Machine

Rest Assured To Buy

We are a company
with solutions

AFTER-SALES VIDEO

YouTube



Warranty of Spare Parts

Spare Parts guarantee for
one year since client
received machine



Technical Engineer Support

Send technician for installation &
training, the cost cover by buyer
(round ticket, accommodation,
Salary of USD 150 Each day)



Operation Manuals & Online Supports

We will provide the operation CD
and manual, we also supply the 24 hours
online service.



Bussiness Support

We will offer the most professional
suggestion to help you start and
expand your business

Ruian Mingyuan Machinery Co., Ltd

Good Service Win Client Trust

13

We will send the ultrasonic control box by DHL .

下午3:20 ✓✓

Hi Andy,
Thanks for listening.
In fact, you are fantastic. I will never change suppliers ...

 **Reliable Quality**

Ok, you, your Company is so much cooperative. I always remember your company.

下午2:49

 **Excellent Service**

Thank you. 下午2:50 ✓✓

Ok, Some one call me from Dhaka to know about machine. I tell him my experience.

下午3:02

de the production line will be fine we will buy you 5 more machines

07:55

 **Trustworthy**

dont worry, we have more than 12years exprience in manufacture and export

07:56 ✓✓

It will be a pleasure collaborate with you company ASAP

下午4:21

 **Pleasure Cooperation**

. It is nice to cooperate

下午4:22 ✓✓

Ruian Mingyuan Machinery Co., Ltd

Certificates

MINGYUAN MACHINERY

MINGYUAN MACHINERY

MINGYUAN MACHINERY

MINGYUAN MACHINERY



MINGYUAN MACHINERY

MINGYUAN MACHINERY

MINGYUAN MACHINERY

MINGYUAN MACHINERY

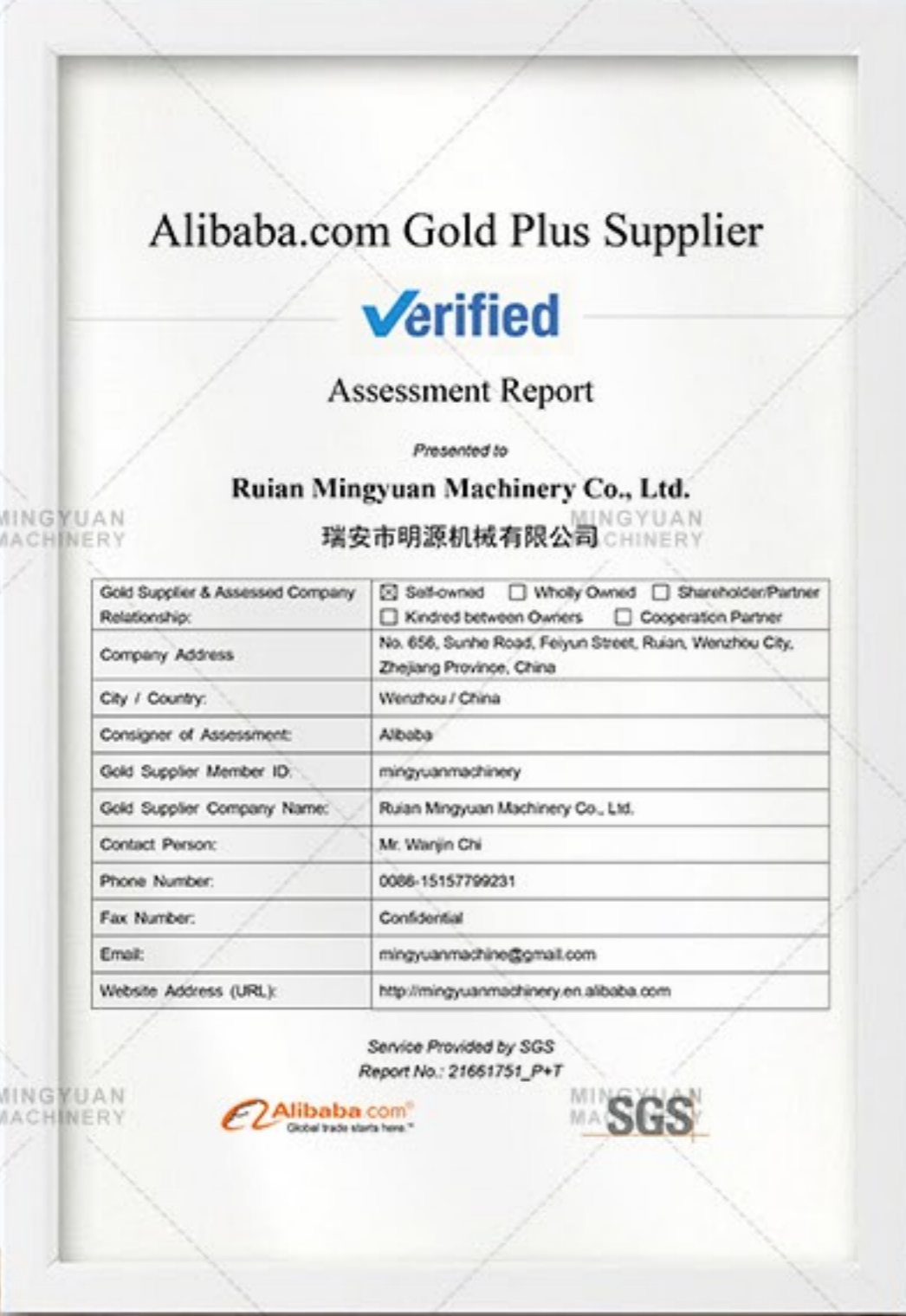

MINGYUAN MACHINERY

MINGYUAN MACHINERY

MINGYUAN MACHINERY

MINGYUAN MACHINERY

Company View Image

MINGYUAN MACHINERY

MINGYUAN MACHINERY

MINGYUAN MACHINERY

MINGYUAN MACHINERY



MINGYUAN MACHINERY

MINGYUAN MACHINERY

MINGYUAN MACHINERY

MINGYUAN MACHINERY

Other Machine



Ultrasonic Non-woven packing Machine



Powder packing Machine



Nylon Triangle Bag Packing Machine



Bag Type Particle Packing Machine



Granule Packing Machine



High-speed Granule Packing Machine